

Plusminus solo

6330

AM
STUDIO
CUSTOM LIGHTING

VIBIA

Design By Diez Office

The recessed version of Plusminus Solo is easily adjustable by rotating it around on itself. Provides direct accent light.

Spec sheet

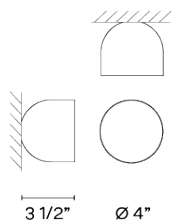

Finish

- 11 Black
NCS S 8500-N
- 53 Green M1
NCS S 6005-G80Y
- 42 Blue M1
NCS S 5010-B10G
- 24 Beige M1
NCS S 2005-Y50R
- 37 Terra Red
NCS S 4040-Y70R

LED

2700 K / 3000 K / 3500 K

Dimming

On/Off / TRIAC / 0-10V

Installation type

Remote

LED

CRI>90 846 lm 107,09
2700 K / 3000 K / 3500 K

Driver

450 120-277 V V 50-60 Hz HZ

LED IP20 Multi-volt Φ 50-60Hz

Application

Ceiling Fixtures

Packaging

1 Box
5.83 m x 6.34 m x 7.6 m
Gross weight 1.48
Net weight 1.08
Vol. 0.1589

Lighting effect

Accent Spotlight

Narrow: Angles less than 20°. Suitable for generating high contrasts or projections at far distances.

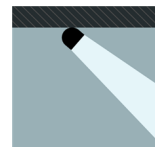

Photometric Data

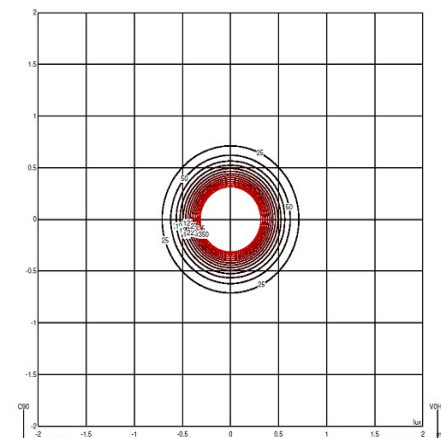
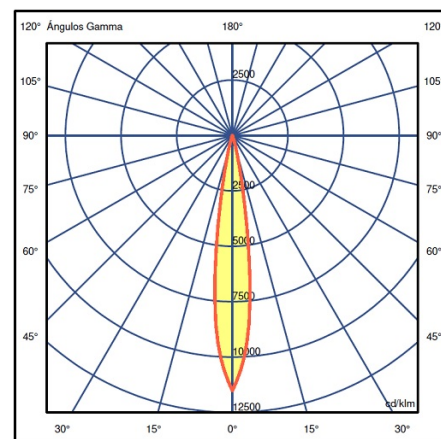

Efficiency 46.187 lm/W
Coordination System CG
Total Flux 365 lm
Maximum Value 11513.12 cd/klm

Any modifications require a minimum order quantity and extra lead time

All of our products come with a two year standard warranty. Check US & Canada Term and Condition sales@vibia.com

VIBIA, INC.

Office / Oficina
272 Fernwood Ave. Edison, NJ 08837. USA

International T 732 417 1700
Spain / Portugal T +34 934 796 970

sales@vibia.com
www.vibia.com/us/usa

Plusminus solo

6331

Design By Diez Office

VIBIA

The recessed version of Plusminus Solo is easily adjustable by rotating around on itself. Provides direct accent light

Spec sheet

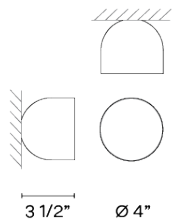

Finish

- 24 Beige M1
NCS S 2005-Y50R
- 53 Green M1
NCS S 6005-G80Y
- 42 Blue M1
NCS S 5010-B10G
- 37 Terra Red
NCS S 4040-Y70R
- 11 Black
NCS S 8500-N

LED

2700 K / 3000 K / 3500 K

Dimming

DALI / 0-10V / TRIAC

Installation type

Remote

LED

CRI>90
2700 K / 3000 K / 3500 K

Driver

Constant Current 450 120~277 V V
50~60 Hz HZ

Dimmable LED IP20 Multi-volt

Application

Ceiling Fixtures

Packaging

Box

Gross weight
Net weight

Lighting effect

Accent Spotlight

Narrow: Angles less than 20°. Suitable for generating high contrasts or projections at far distances.

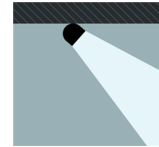

Photometric Data

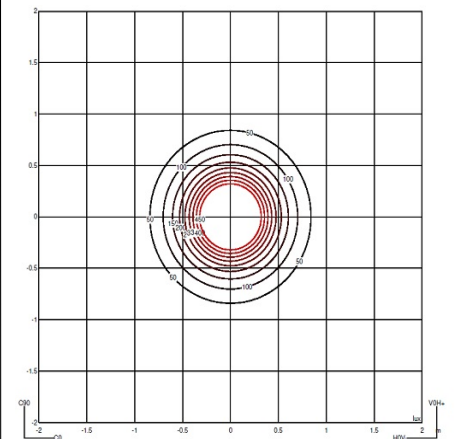
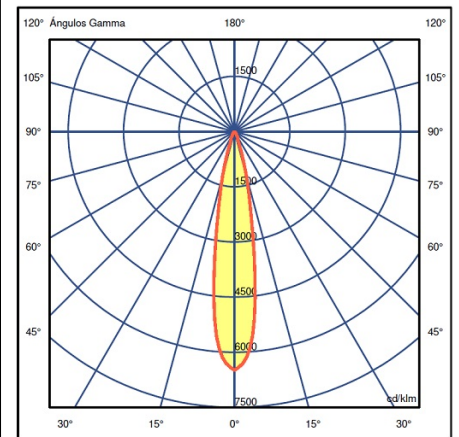

Efficiency

83.285 lm/W

Coordination System

CG

Total Flux

658 lm

Maximum Value

6482.33 cd/klm

Any modifications require a minimum order quantity and extra lead time

All of our products come with a two year standard warranty. Check US & Canada Term and Condition sales@vibia.com

VIBIA, INC.

Office / Oficina
272 Fernwood Ave. Edison, NJ 08837. USA

International T 732 417 1700
Spain / Portugal T +34 934 796 970

sales@vibia.com
www.vibia.com/us/usa

Plusminus solo

6332

VIBIA

Design By Diez Office

The recessed version of Plusminus Solo is easily adjustable by rotating it around on itself. Provides direct accent light.

Spec sheet

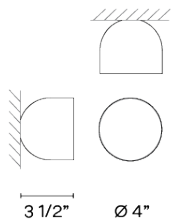

Finish

- 24 Beige M1
NCS S 2005-Y50R
- 42 Blue M1
NCS S 5010-B10G
- 37 Terra Red
NCS S 4040-Y70R
- 11 Black
NCS S 8500-N
- 53 Green M1
NCS S 6005-G80Y

LED

2700 K / 3000 K / 3500 K

Dimming

0-10V / On/Off / TRIAC

Installation type

Remote

LED

CRI>90
2700 K / 3000 K / 3500 K

Driver

Constant Current 450 120~277 V V
50~60 Hz HZ

LED IP20 Multi-volt Φ 50-60Hz

Application

Ceiling Fixtures

Packaging

Box

Gross weight
Net weight

Lighting effect

Accent Spotlight

Narrow: Angles less than 20°. Suitable for generating high contrasts or projections at far distances.

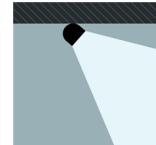

Photometric Data

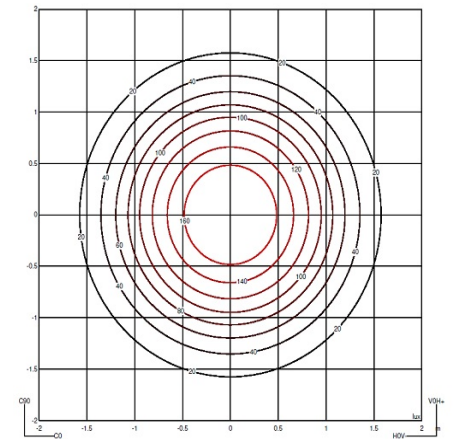
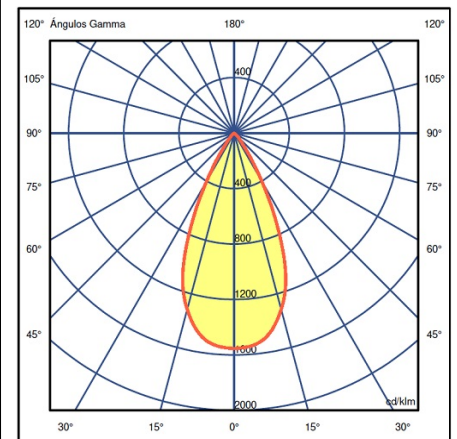

Efficiency 92.639 lm/W
Coordination System CG
Total Flux 732 lm
Maximum Value 1552.05 cd/klm

Any modifications require a minimum order quantity and extra lead time

All of our products come with a two year standard warranty. Check US & Canada Term and Condition sales@vibia.com

VIBIA, INC.

Office / Oficina

272 Fernwood Ave. Edison, NJ 08837. USA

International T 732 417 1700

Spain / Portugal T +34 934 796 970

sales@vibia.com

www.vibia.com/us/usa

Plusminus solo

6333

VIBIA

Design By Diez Office

The recessed version of Plusminus Solo is easily adjustable by rotating it around on itself. Provides a diffused light.

Spec sheet

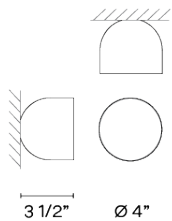

Any modifications require a minimum order quantity and extra lead time

Finish

53 Green M1
NCS S 6005-G80Y

37 Terra Red
NCS S 4040-Y70R

11 Black
NCS S 8500-N

24 Beige M1
NCS S 2005-Y50R

42 Blue M1
NCS S 5010-B10G

LED

2700 K / 3000 K / 3500 K

Dimming

On/Off / 0-10V / TRIAC

Installation type

Remote

LED

CRI>90
2700 K / 3000 K / 3500 K

Driver

250 120~277 V V 50~60 Hz HZ

LED IP20 Multi-volt 50-60Hz

Application

Ceiling Fixtures

Packaging

Box

Gross weight
Net weight

Lighting effect

General Flat Diffuser

First layer of basic, general illumination

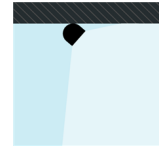

Photometric Data

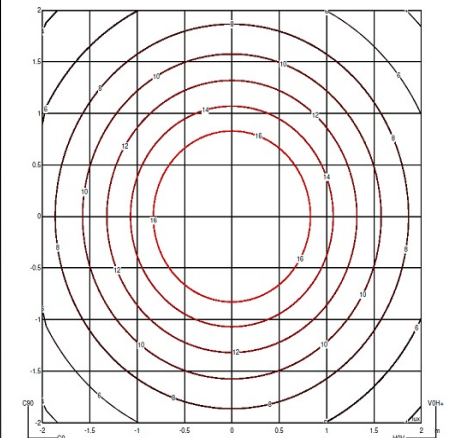
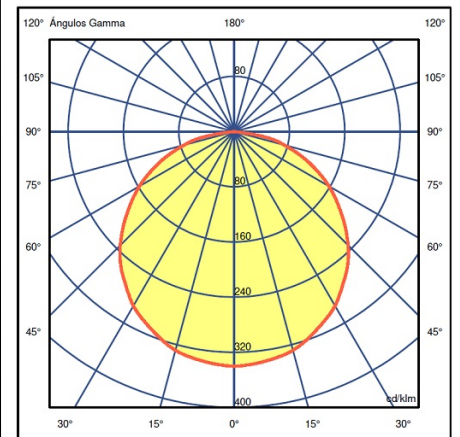

Efficiency 86.667 lm/W
Coordination System CG
Total Flux 364 lm
Maximum Value 340.24 cd/klm

VIBIA, INC.

Office / Oficina
272 Fernwood Ave. Edison, NJ 08837. USA

International T 732 417 1700
Spain / Portugal T +34 934 796 970

sales@vibia.com
www.vibia.com/us/usa

All of our products come with a two year standard warranty. Check US & Canada Term and Condition sales@vibia.com

Plusminus solo

6335

VIBIA



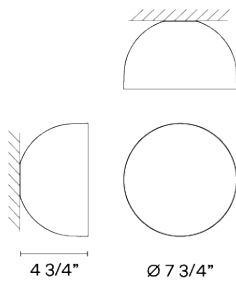
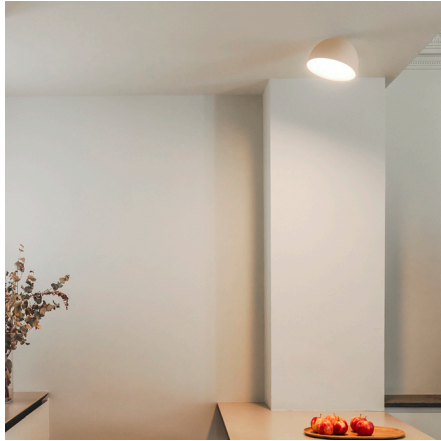

Design By Diez Office

The recessed version of Plusminus Solo is easily adjustable by rotating it around on itself. Provides a diffuse light.

Spec sheet



Finish

-  53 Green M1
NCS S 6005-G80Y
-  42 Blue M1
NCS S 5010-B10G
-  24 Beige M1
NCS S 2005-Y50R
-  11 Black
NCS S 8500-N
-  37 Terra Red
NCS S 4040-Y70R

LED

2700 K / 3000 K / 3500 K

Dimming

On/Off / TRIAC / 0-10V

Installation type

Remote

LED

CRI>90
2700 K / 3000 K / 3500 K

Driver

Constant Current 450 120~277 V V
50~60 Hz HZ

LED IP20 Multi-volt Φ 50-60Hz

Application

Ceiling Fixtures

Packaging

Box

Gross weight
Net weight

Lighting effect

General Flat Diffuser

First layer of basic, general illumination

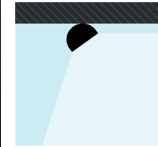

Photometric Data

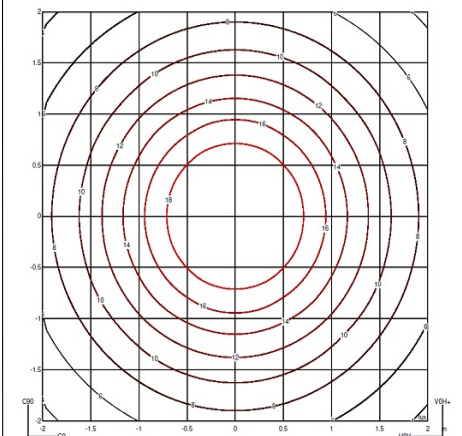
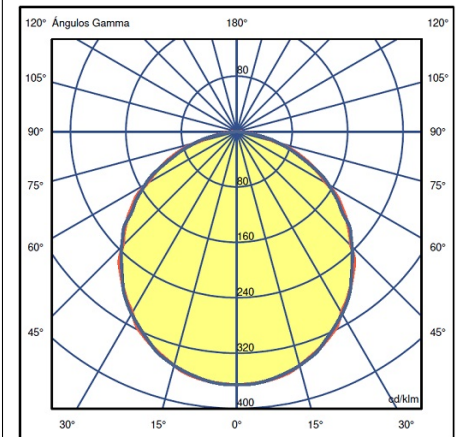

Efficiency 46.041 lm/W
Coordination System CG
Total Flux 364 lm
Maximum Value 365.65 cd/klm

Any modifications require a minimum order quantity and extra lead time

All of our products come with a two year standard warranty. Check US & Canada Term and Condition sales@vibia.com

VIBIA, INC.

Office / Oficina

272 Fernwood Ave. Edison, NJ 08837. USA

International T 732 417 1700

Spain / Portugal T +34 934 796 970

sales@vibia.com

www.vibia.com/us/usa

Plusminus solo

6340

Design By Diez Office

VIBIA

The recessed version of Plusminus Solo is easily adjustable by rotating it around on itself. Provides a diffuse light.

Spec sheet

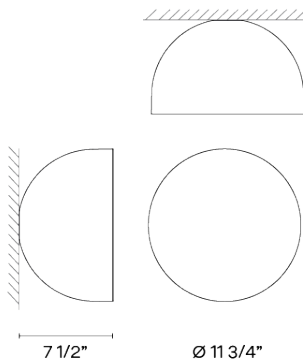

Finish

- 42 Blue M1
NCS S 5010-B10G
- 11 Black
NCS S 8500-N
- 24 Beige M1
NCS S 2005-Y50R
- 53 Green M1
NCS S 6005-G80Y
- 37 Terra Red
NCS S 4040-Y70R

LED

2700 K / 3000 K / 3500 K

Dimming

TRIAC / On/Off / 0-10V

Installation type

Remote

LED

CRI>90
2700 K / 3000 K / 3500 K

Driver

Constant Current 850 120~277 V V
50~60 Hz HZ

LED Multi-volt 50-60Hz 1-10V

Application

Ceiling Fixtures

Packaging

Box

Gross weight
Net weight

Lighting effect

General Flat Diffuser

First layer of basic, general illumination

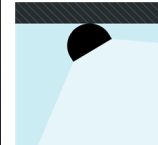

Photometric Data

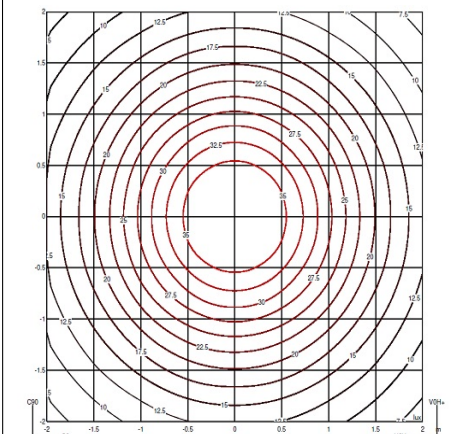
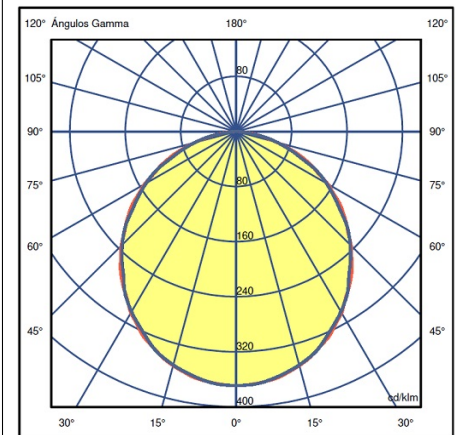

Efficiency 41.115 lm/W
Coordination System CG
Total Flux 658 lm
Maximum Value 368.98 cd/klm

Min. Quantity, upcharge and extra lead time apply

All of our products come with a two year standard warranty. Check US & Canada Term and Condition sales@vibia.com

VIBIA, INC.

Office / Oficina

272 Fernwood Ave. Edison, NJ 08837. USA

International T 732 417 1700

Spain / Portugal T +34 934 796 970

sales@vibia.com

www.vibia.com/us/usa